

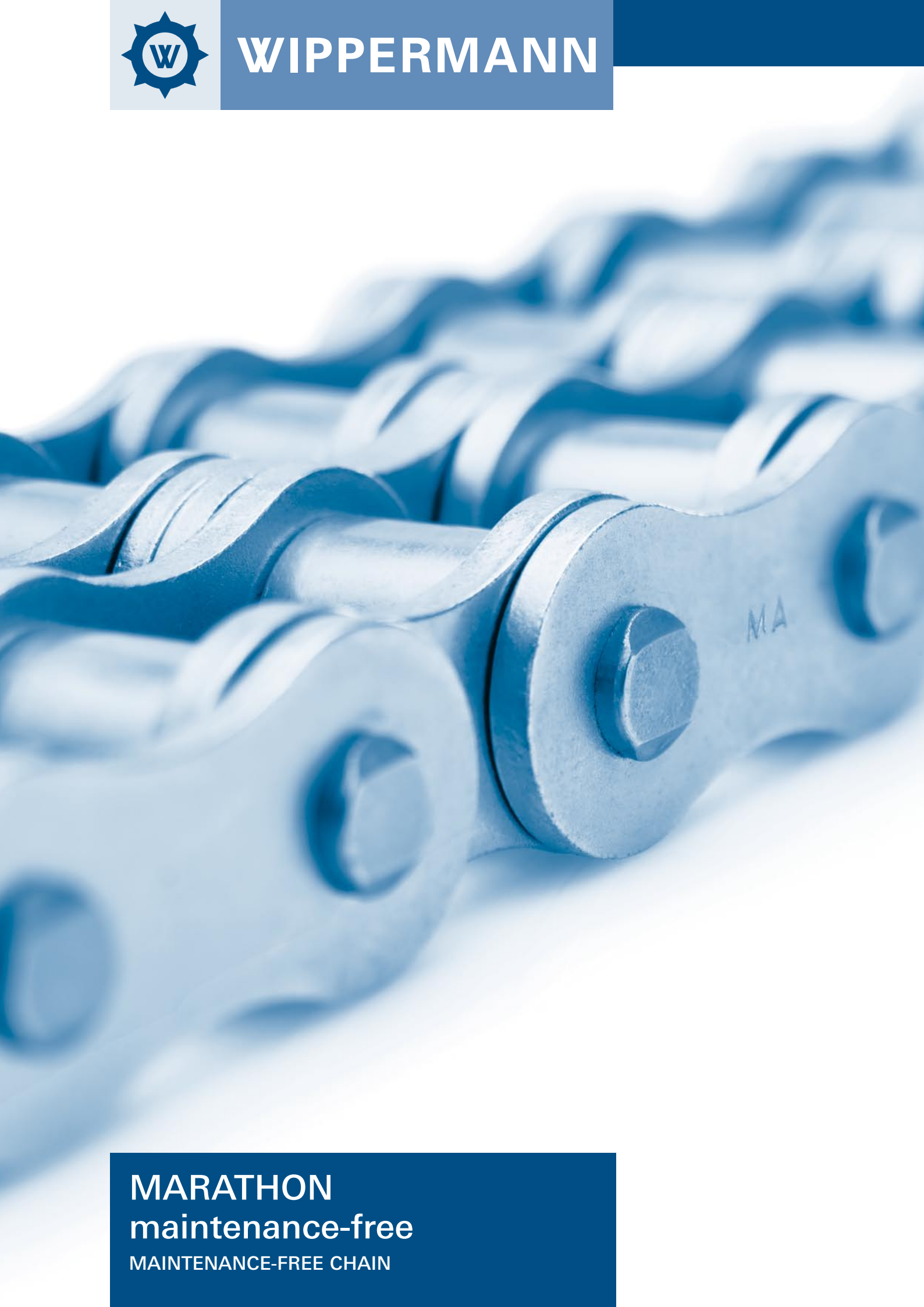

WIPPERMANN



MARATHON
maintenance-free
MAINTENANCE-FREE CHAIN



MARATHON, the long distance chain that needs no relubrication:

- High-performance bearing joints
- Tensile strength according to WIPPERMANN standard
- Electrogalvanised surface for optimum protection
- Bushings with slight projection over plates



Advantages of the WIPPERMANN MARATHON chain:

- Up to 35 times longer wear life in comparison with other standard roller chains without lubrication
- Up to 5 times longer wear life than other maintenance-free chains
- No relubrication required
- Clean application with no soiling of machinery and transported goods
- Joint bushings made with a new type of sintered metal with high strength treated with a special lubricant
- Bushings longer than the width of the chain link with sliding contact to the outer plate
- The pins forming the joints with these bushings are made of alloyed hardened steel and are treated with a special coating. The resulting high-wearing coat guarantees an excellent sliding performance.
- Same tensile strength as with WIPPERMANN standard chains
- All MARATHON chains fit standard sprockets

Range of application for WIPPERMANN MARATHON chains:

- Temperatures from 0°C to +100°C
- With special lubrication from -30°C to +250°C (after consultation)
- Speeds of up to $v = 150$ m/min.
- Food industry
- Electrical industry
- Production of printed circuit boards (PCBs)
- Television industry
- Packing industry
- Paper processing
- Printing industry
- Bookbinding industry
- Textile industry
- Automotive industry
- All systems where relubrication is either not wanted, problematic or not possible at all.

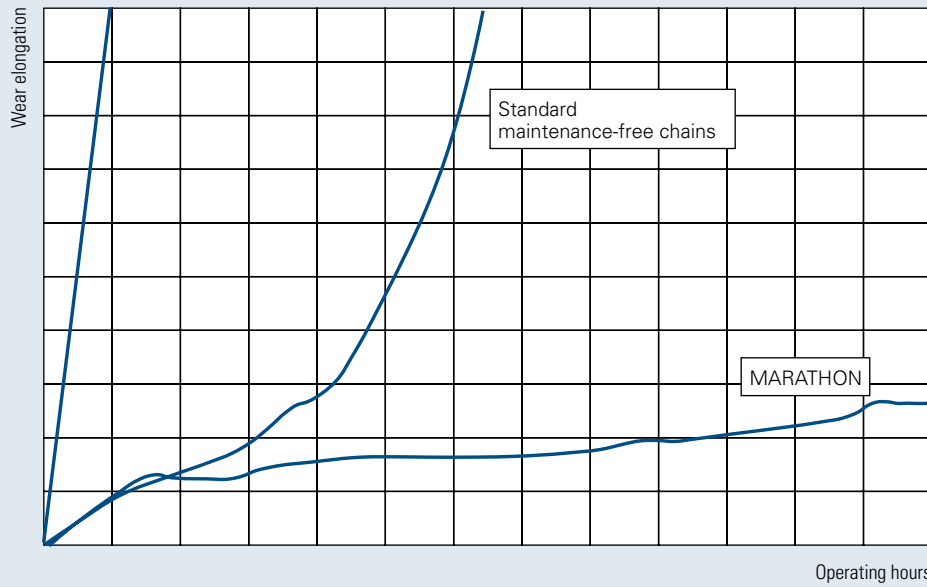

Results of long-term wear tests

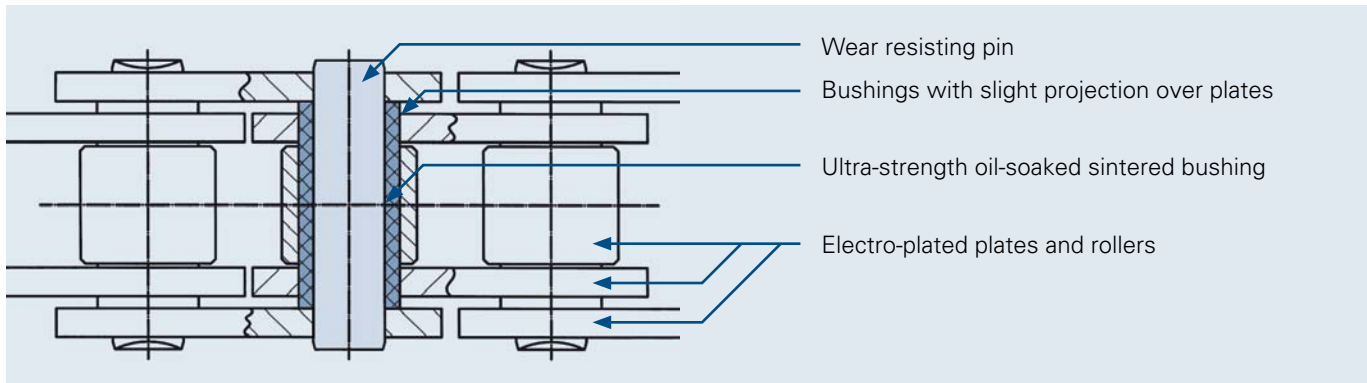

Type of test: Tensile test
Object: 548 Marathon chain
Test length: 5 links

Minimum tensile strength: 78,000 N
Breaking point: Pins

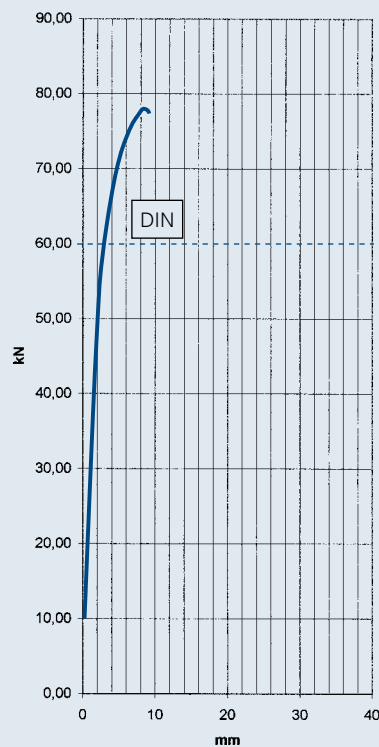

Force projection diagram



Simplex chains

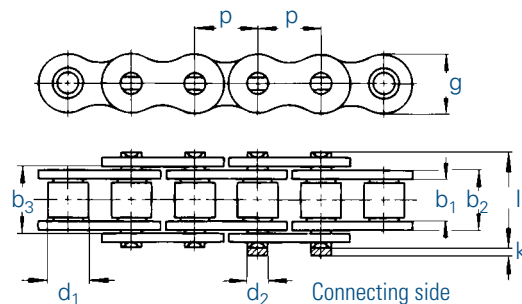

Duplex chains

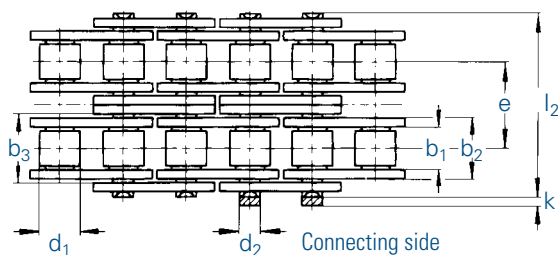

Triplex chains

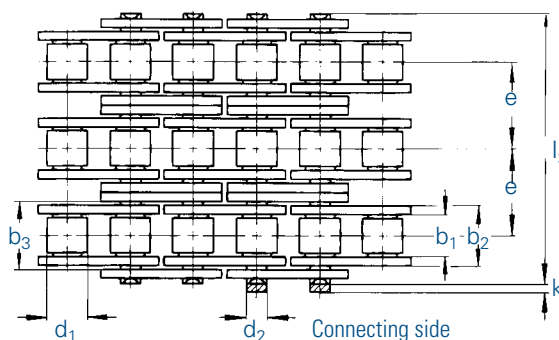

Chain		Pitch		Inner width	Inner link width	Outer plate width	Roller Ø	Pin Ø	Transverse pitch	Plate height	Projection over connecting link	Width over pin	Bearing area	Minimum tensile strength	Weight	Connecting links
⚙		p		b ₁ min.	b ₂ max.	b ₃ min.	d ₁ max.	d ₂ max.	e	g max.	k max.	l max.	f	F _B min.	q ≈	No.
No.	Ind.	mm	inch	mm	mm	mm	mm	mm	mm	mm	mm	mm	cm ²	kN	kg/m	No.
06 B-1 MA	¹	9,525	3/8	5,72	8,53	8,66	6,35	3,28	-	8,2	3,3	13,5	0,28	9,6	0,41	11,12,15
08 B-1 MA		12,7	1/2	7,75	11,30	11,43	8,51	4,45	-	11,8	3,9	17,0	0,50	18,6	0,70	11,12,15
10 B-1 MA		15,875	5/8	9,65	13,28	13,41	10,16	5,08	-	14,7	4,1	19,6	0,67	27,0	0,91	11,12,15
12 B-1 MA		19,05	3/4	11,68	15,62	15,75	12,07	5,72	-	16,1	4,6	22,7	0,89	31,0	1,18	11,12,15
16 B-1 MA		25,4	1	17,02	25,40	25,60	15,88	8,28	-	21,0	5,4	36,1	2,10	72,0	2,68	11,111,12
552 MA		30,0	-	17,02	25,40		15,88	8,28	-	21,0	5,4	36,1	2,10	72,0	2,50	11,111,12
20 B-1 MA		31,75	1 1/4	19,56	29,00	29,20	19,05	10,19	-	26,4	6,1	43,2	2,96	105,0	3,50	111,12
24 B-1 MA		38,1	1 1/2	25,40	37,90	38,20	25,40	14,63	-	33,4	6,6	53,4	5,54	180,0	6,80	111,12
06 B-2 MA		9,525	3/8	5,72	8,53	8,66	6,35	3,28	10,24	8,2	3,3	23,8	0,56	17,4	0,78	11,12,15
08 B-2 MA		12,7	1/2	7,75	11,30	11,43	8,51	4,45	13,92	11,8	3,9	31,0	1,01	37,0	1,36	11,12,15
10 B-2 MA		15,875	5/8	9,65	13,28	13,41	10,16	5,08	16,59	14,7	4,1	36,2	1,34	54,0	1,82	11,12,15
12 B-2 MA		19,05	3/4	11,68	15,62	15,75	12,07	5,72	19,46	16,1	4,6	42,2	1,79	63,0	2,38	11,12,15
16 B-2 MA		25,4	1	17,02	25,40	25,60	15,88	8,28	31,88	21,0	5,4	68,0	4,21	140,0	5,30	11,111,12
20 B-2 MA		31,75	1 1/4	19,56	25,40	29,20	19,05	10,19	36,45	26,4	6,1	79,0	5,91	210,0	7,30	111,12
24 B-2 MA		38,1	1 1/2	25,40	37,90	38,20	25,40	14,63	48,36	33,4	6,6	101,0	11,09	360,0	13,40	111,12
06 B-3 MA		9,525	3/8	5,72	8,53	8,66	6,35	3,28	10,24	8,2	3,3	34,0	0,81	24,9	1,18	11,12,15
08 B-3 MA		12,7	1/2	7,75	11,30	11,43	8,51	4,45	13,92	11,8	3,9	44,9	1,51	56,0	2,01	11,12,15
10 B-3 MA		15,875	5/8	9,65	13,28	13,41	10,16	5,08	16,59	14,7	4,1	52,8	2,02	80,0	2,70	11,12,15
12 B-3 MA		19,05	3/4	11,68	15,62	15,75	12,07	5,72	19,46	16,1	4,6	61,7	2,68	94,0	3,12	11,12,15
16 B-3 MA		25,4	1	17,02	25,40	25,60	15,88	8,28	31,88	21,0	5,4	99,9	6,31	211,0	7,50	11,111,12
20 B-3 MA		31,75	1 1/4	19,56	29,00	29,20	19,05	10,19	36,45	26,4	6,1	116,0	8,87	300,0	10,60	111,12
24 B-3 MA		38,1	1 1/2	25,40	37,90	38,20	25,40	14,63	48,36	33,4	6,6	150,0	16,63	523,0	20,00	111,12

¹ with straight side plates

Standard sprockets can be used for these chains.



Simplex chains

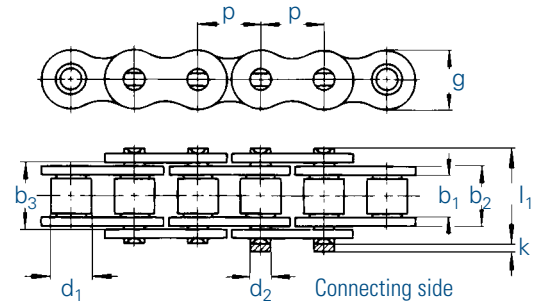

Duplex chains

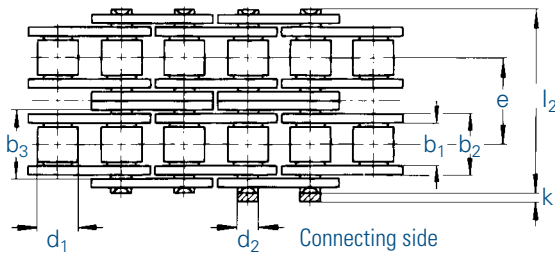

Triplex chains

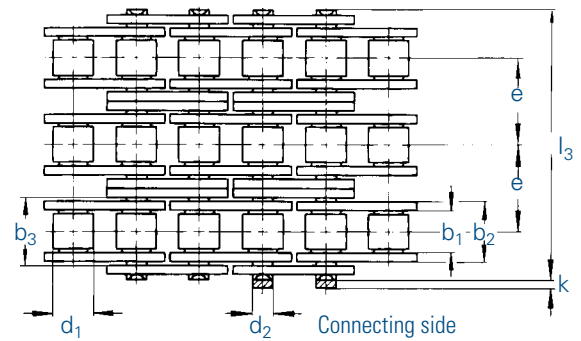

Chain		Pitch		Inner width	Inner link width	Outer plate width	Roller Ø	Pin Ø	Transverse pitch	Plate height	Projection over connecting link	Width over pin	Bearing area	Minimum tensile strength	Weight	Connecting links
⚙		p		b ₁ min.	b ₂ max.	b ₃ min.	d ₁ max.	d ₂ max.	e	g max.	k max.	l max.	f	F _B min.	q ≈	No.
No.	Ind.	mm	inch	mm	mm	mm	mm	mm	mm	mm	mm	mm	cm ²	kN	kg/m	No.
08 A-1 MA		12,7	1/2	7,85	11,15	11,28	7,95	3,96	-	12,0	3,9	17,8	0,44	16,5	0,60	11,12,15
10 A-1 MA		15,875	5/8	9,40	13,80	13,93	10,16	5,08	-	15,0	4,1	21,8	0,70	30,0	1,01	11,12,15
12 A-1 MA		19,05	3/4	12,57	17,70	17,85	11,91	5,94	-	18,0	4,6	26,9	1,05	40,0	1,58	11,111,12,15
16 A-1 MA		25,4	1	15,75	22,50	22,70	15,88	7,92	-	24,1	5,4	33,5	1,78	69,0	2,36	11,111,12,15
20 A-1 MA		31,75	1 1/4	18,90	27,40	27,60	19,05	9,53	-	30,1	6,1	41,1	2,61	92,5	3,80	111,12
24 A-1 MA		38,1	1 1/2	25,22	35,30	35,60	22,23	11,10	-	36,2	6,6	50,8	3,92	139,0	5,40	111,12
08 A-2 MA		12,7	1/2	7,85	11,15	11,28	7,95	3,96	14,38	12,0	3,9	32,3	0,88	29,7	1,20	11,12,15
10 A-2 MA		15,875	5/8	9,40	13,80	13,93	10,16	5,08	18,11	15,0	4,1	39,9	1,40	62,0	1,78	11,12,15
12 A-2 MA		19,05	3/4	12,57	17,70	17,85	11,91	5,94	22,78	18,0	4,6	49,8	2,10	76,0	3,15	11,111,12,15
16 A-2 MA		25,4	1	15,75	22,50	22,70	15,88	7,92	29,29	24,1	5,4	62,7	3,56	135,0	4,90	11,111,12,15
20 A-2 MA		31,75	1 1/4	18,90	27,40	27,60	19,05	9,53	35,76	30,1	6,1	77,0	5,22	205,0	7,60	111,12
24 A-2 MA		38,1	1 1/2	25,22	35,30	35,60	22,23	11,10	45,44	36,2	6,6	96,3	7,84	290,0	10,80	111,12
08 A-3 MA		12,7	1/2	7,85	11,15	11,28	7,95	3,96	14,38	12,0	3,9	46,7	1,32	41,2	1,80	11,12,15
10 A-3 MA		15,875	5/8	9,40	13,80	13,93	10,16	5,08	18,11	15,0	4,1	57,9	2,10	88,0	3,02	11,12,15
12 A-3 MA		19,05	3/4	12,57	17,70	17,85	11,91	5,94	22,78	18,0	4,6	72,6	3,15	105,0	4,70	11,111,12,15
16 A-3 MA		25,4	1	15,75	22,50	22,70	15,88	7,92	29,29	24,1	5,4	91,7	5,35	193,0	7,50	11,111,12,15
20 A-3 MA		31,75	1 1/4	18,90	27,40	27,60	19,05	9,53	35,76	30,1	6,1	113,0	7,83	305,0	11,20	111,12
24 A-3 MA		38,1	1 1/2	25,22	35,30	35,60	22,23	11,10	45,44	36,2	6,6	141,0	11,76	410,0	16,10	111,12

Standard sprockets can be used for these chains.



MARATHON - MAINTENANCE-FREE

Roller chains type series GL (straight plates)



Simplex chains

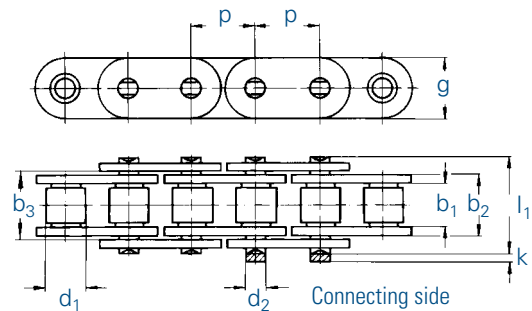

Duplex chains

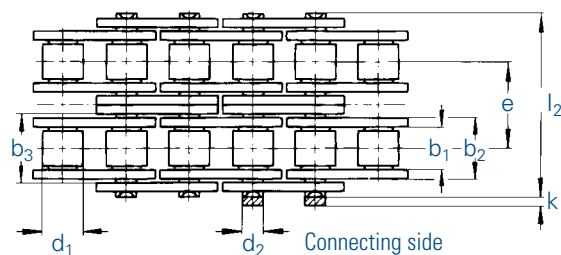

Triplex chains

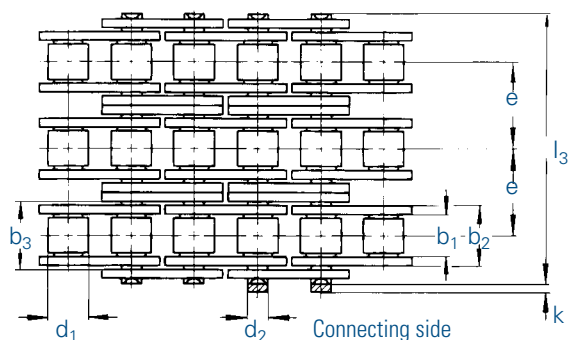

Chain		Pitch		Inner width	Inner link width	Outer plate width	Roller Ø	Pin Ø	Transverse pitch	Plate height	Projection over connecting link	Width over pin	Bearing area	Minimum tensile strength	Weight	Connecting links	
No.		Ind.	mm	inch	b ₁ min.	b ₂ max.	b ₃ min.	d ₁ max.	d ₂ max.	e	g max.	k max.	l max.	f	F _B min.	q ≈	No.
455 GL MA			9,525	3/8	5,72	8,53	8,66	6,35	3,28	-	8,2	3,3	13,5	0,28	9,6	0,41	4,7,11,12,15
462 GL MA			12,7	1/2	7,75	11,30	11,43	8,51	4,45	-	11,5	3,9	17,0	0,50	18,6	0,78	4,7,11,12
501 GL MA			15,875	5/8	9,65	13,28	13,41	10,16	5,08	-	14,2	4,1	19,6	0,67	27,0	1,03	4,7,11
513 GL MA			19,05	3/4	11,68	15,62	15,75	12,07	5,72	-	15,5	4,6	22,7	0,89	31,0	1,29	4,7,11,12
548 GL MA			25,4	1	17,02	25,40	25,60	15,88	8,28	-	24,0	5,4	36,1	2,10	72,0	3,29	4,7,11
548 GLS MA			25,4	1	17,02	25,40	25,60	15,88	8,28	-	21,0	5,4	36,1	2,10	72,0	2,90	4,7,11,12
563 GL MA			31,75	1 1/4	19,56	29,00	29,20	19,05	10,19	-	26,4	6,1	43,2	2,95	105,0	4,13	4,7,11,12
596 GL MA			38,1	1 1/2	25,40	37,90	38,20	25,40	14,63	-	33,4	6,6	53,4	5,54	180,0	7,34	4,7,11,12
455 GL-2MA			9,525	3/8	5,72	8,53	8,66	6,35	3,28	10,24	8,2	3,3	23,8	0,56	17,4	0,86	4,7,11,12,15
462 GL-2MA			12,7	1/2	7,75	11,30	11,43	8,51	4,45	13,92	11,5	3,9	31,0	1,01	37,0	1,50	4,7,11,12
501 GL-2MA			15,875	5/8	9,65	13,28	13,41	10,16	5,08	16,59	14,2	4,1	36,2	1,34	54,0	2,00	4,7,11
513 GL-2MA			19,05	3/4	11,68	15,62	15,75	12,07	5,72	19,46	15,5	4,6	42,2	1,79	63,0	2,62	4,7,11,12
548 GL-2MA			25,4	1	17,02	25,40	25,60	15,88	8,28	31,88	24,0	5,4	68,0	4,21	140,0	5,83	4,7,11
563 GL-2MA			31,75	1 1/4	19,56	29,00	29,20	19,05	10,19	36,45	26,4	6,1	79,0	5,81	210,0	8,03	4,7,11,12
596 GL-2MA			38,1	1 1/2	25,40	37,92	38,20	25,40	14,63	48,36	33,4	6,6	101,0	11,09	360,0	14,47	4,7,11,12
455 GL-3MA			9,525	3/8	5,72	8,53	8,66	6,35	3,28	10,24	8,2	3,3	34,0	0,81	24,9	1,30	4,7,11,12,15
462 GL-3MA			12,7	1/2	7,75	11,30	11,43	8,51	4,45	13,92	11,5	3,9	44,9	1,51	56,0	2,21	4,7,11,12
501 GL-3MA			15,875	5/8	9,65	13,28	13,41	10,16	5,08	16,59	14,2	4,1	52,8	2,02	80,0	2,97	4,7,11
513 GL-3MA			19,05	3/4	11,68	15,62	15,75	12,07	5,72	19,46	15,5	4,6	61,7	2,68	94,0	3,43	4,7,11,12
548 GL-3MA			25,4	1	17,02	25,40	25,60	15,88	8,28	31,88	24,0	5,4	99,9	6,31	211,0	8,25	4,7,11
563 GL-3MA			31,75	1 1/4	19,56	29,00	29,20	19,05	10,19	36,45	26,4	6,1	116,0	8,87	300,0	11,66	4,7,11,12
596 GL-3MA			38,1	1 1/2	25,40	37,90	38,20	25,40	14,63	48,36	33,4	6,6	150,0	16,63	523,0	22,00	4,7,11,12

Standard sprockets can be used for these chains.

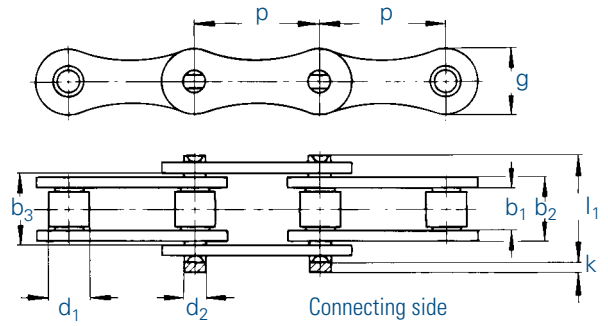

Chain		Pitch		Inner width	Inner link width	Outer plate width	Roller Ø	Pin Ø	Plate height	Projection over connecting link	Width over pin	Bearing area	Minimum tensile strength	Weight
⚙️		p		b ₁ min.	b ₂ max.	b ₃ min.	d ₁ max.	d ₂ max.	g max.	k max.	l ₁ max.	f	F _B min.	q ≈
No.	Ind.	mm	inch	mm	mm	mm	mm	mm	mm	mm	mm	cm ²	kN	kg/m
208 B MA		25,4	1	7,75	11,30	11,43	8,51	4,45	11,8	3,9	17,0	0,50	18,0	0,48
210 B MA		31,75	1 ¼	9,65	13,28	13,40	10,16	5,08	14,7	4,1	19,6	0,67	22,4	0,55
212 B MA		38,1	1 ½	11,68	15,62	15,75	12,07	5,72	16,1	4,6	22,7	0,89	29,0	0,80
216 B MA		50,8	2	17,02	25,40	25,60	15,88	8,28	21,0	5,4	36,1	2,10	60,0	1,74
220 B MA		63,5	2 ½	19,56	29,00	29,20	19,05	10,19	28,0	6,1	43,2	2,96	95,0	2,55

Sprockets for double pitch roller chains can be used for these chains.

Connecting links: According to DIN (...)

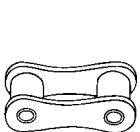

No. 4 (B)
Inner link

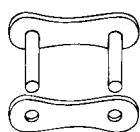

No. 7 (A)
Outer link
(to be riveted)

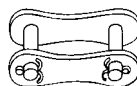

No. 111 (S)
Connecting link with cottered pin
for chain No. 208 B MA with spring clip (E)

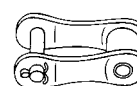

No. 12 (L)
Single cranked link

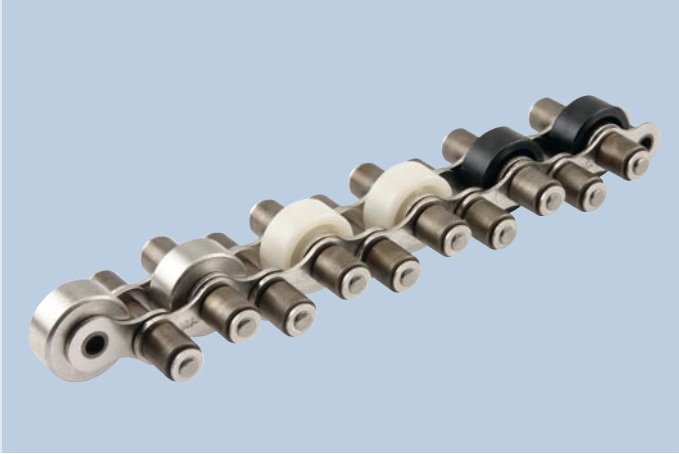

Design E

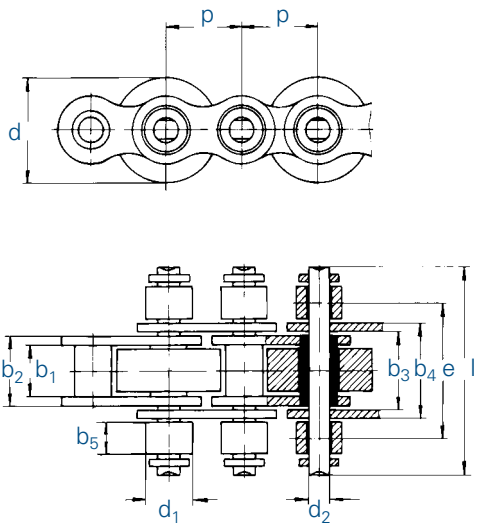

Double pitch chain Design L

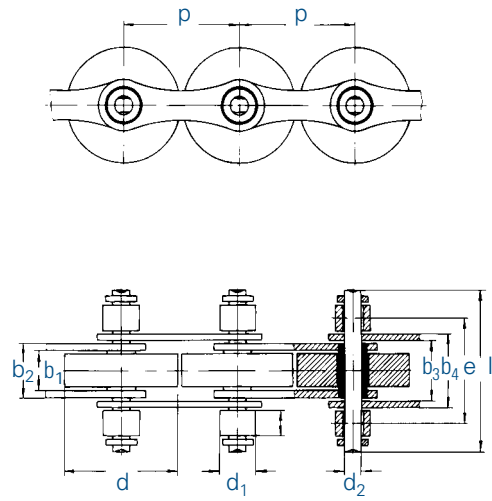

Chain		Pitch		Inner width	Inner link width		Width between over outer plates		Support roller Ø	Pin Ø	Transverse pitch	Plate height	Width over pin	Support roller width	Width over pin Type I	Support roller width
No.	Ind.	p	Design	b ₁ min.	b ₂ max.	b ₃ min.	b ₄ max.	d ₁	d ₂ max.	e	g max.	l max.	b ₅ max.	l max.	b ₅ max.	
		mm		mm	mm	mm	mm	mm	mm	mm	mm	mm	mm	mm	mm	
513 SF MA		19,05	E	11,68	15,62	15,80	20,0	12,00	5,72	31,50	16,1	48,0	11,5	43,0	9,0	
548 SF MA		25,4	E	17,02	25,45	25,81	32,0	15,88	8,28	44,50	21,0	65,0	12,5	-	-	
722 SF MA		38,1	L	11,68	15,62	15,80	20,0	12,00	5,72	31,50	16,1	48,0	11,5	-	-	
728 SF MA		50,8	L	17,02	25,45	25,81	32,0	15,88	8,28	44,50	21,0	65,0	12,5	-	-	
D 513 SF MA		19,05	D	11,68	15,62	15,80	20,0	12,07	5,72	52,00	16,1	68,0	11,5	-	-	
D 548 SF MA		25,4	D	17,02	25,45	25,81	32,0	15,88	8,28	76,76	21,0	97,0	12,5	-	-	
T 513 SF MA		19,05	T	11,68	15,62	15,80	20,0	12,07	5,72	38,92	16,1	61,7	-	-	-	
T 548 SF MA		25,4	T	17,02	25,45	25,81	32,0	15,88	8,28	63,76	21,0	99,9	-	-	-	

Sprockets are available for all accumulator chains!

Connecting links with securing circlips.

Our connecting links always have the same length l as the ordinary pins.

Temperature range: - 30 to 100°C for steel conveyor rollers
- 10 to 60°C for plastic conveyor rollers



Design D

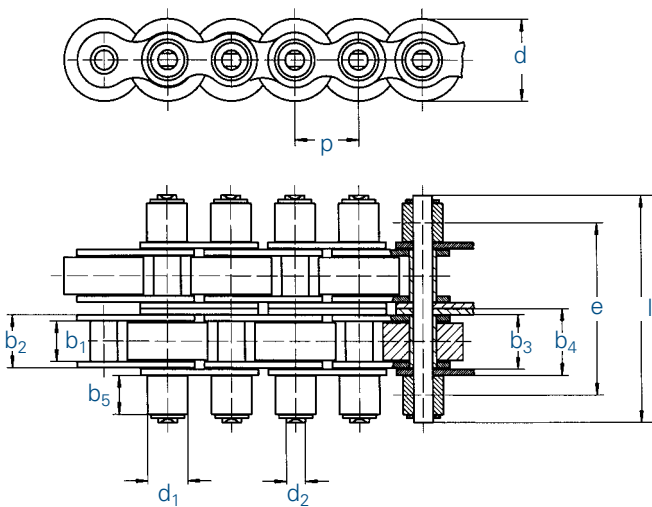

Design T

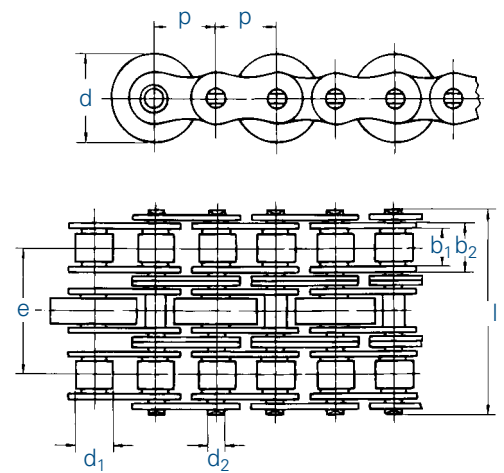

Width over pin Type II	Support roller width	Conveyor rollers					Minimum tensile strength	Maximum load per m conveyor chain with 10 m conveyor length		
		Designation for material			Diameter	Type I d		Type II d	Steel	Plastic
I max.	b ₅ max.	Steel	PA 6.6	Vestamide			d			
mm.	mm				mm	mm	mm	kN	kg	kg
40,0	7,5	SF	SFK	SFV	24,0	26,0	28,0	29,0	300	260
-	-	SF	SFK	SFV	38,5	-	-	60,0	600	500
-	-	SF	SFK	SFV	24,0	26,0	28,0	29,0	300	260
-	-	SF	SFK	SFV	38,5	40,0	50,0	60,0	600	500
-	-	SF	SFK	SFV	24,0	26,0	28,0	57,8	600	520
-	-	SF	SFK	SFV	38,5	-	-	120,0	1200	1000
-	-	SF	SFK	SFV	24,0	26,0	28,0	60,0	600	260
-	-	SF	SFK	SFV	38,5	-	-	120,0	1200	500

The load per m applies for 10 m conveyor length per double chain strand. The load may be proportionally increased for shorter chain lengths and must be proportionally decreased for longer conveyor distances: e.g. 5 m conveyor distance = double load, 20 m conveyor distance = half load.

Maximum conveyor distances 25 - 30 m. The installation of guide plates is recommended as of 15 m.

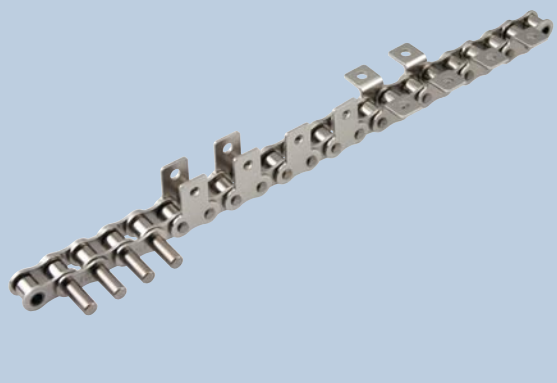

Type A bent attachments, one side

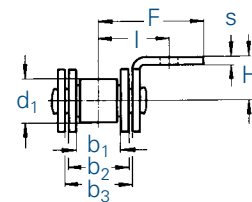
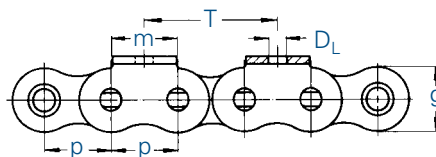

Type B bent attachments, both sides

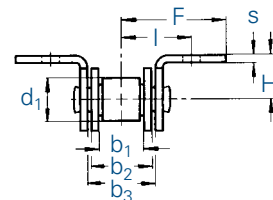
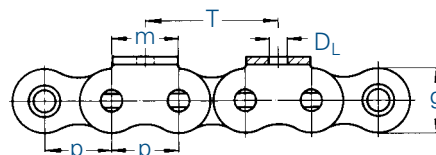

Type C bent over chain attachments, one side

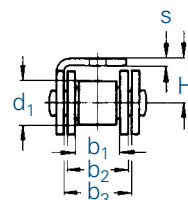
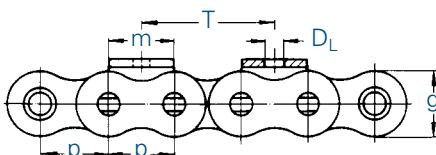

Type D straight attachments, one side

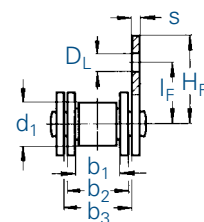
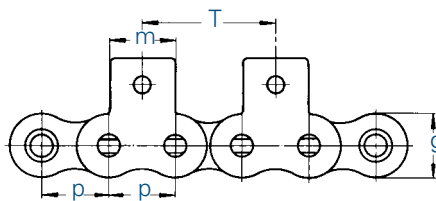

Type E straight attachments, both sides

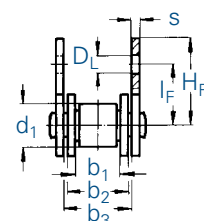
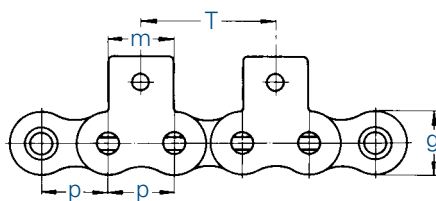

Basic chain		Pitch p	Inner width b ₁ min.	Inner link width b ₂ max.	Outer plate width b ₃ min.	Roller Ø d ₁ max.	Plate height g max.	Attachment dimensions							
No.	Ind.							m	D _L	l	F	H	I _F	H _F	s
06 B-1 MA	¹	9,525	5,72	8,53	8,66	6,35	8,2	8,0	3,5	9,5	13,5	6,5	9,0	13,8	1,25
08 B-1 MA		12,7	7,75	11,30	11,43	8,51	11,8	12,5	4,5	13,1	19,0	10,0	14,7	20,3	1,60
10 B-1 MA		15,875	9,65	13,28	13,41	10,16	14,7	15,0	5,5	16,7	27,0	10,0	17,2	26,7	1,70
12 B-1 MA		19,05	11,68	15,62	15,75	12,07	16,1	18,5	6,6	18,6	29,0	11,0	18,7	29,0	1,80
16 B-1 MA		25,4	17,02	25,40	25,60	15,88	21,0	25,0	9,0	28,9	41,8	18,0	28,6	41,5	3,00
20 B-1 MA		31,75	19,56	29,00	29,20	19,05	26,4	35,0	9,0	33,4	50,0	18,0	30,5	45,7	3,75
24 B-1 MA		38,1	25,40	37,90	38,20	25,40	33,4	38,0	11,0	44,0	64,0	25,0	41,0	60,0	5,00

¹ with straight side plates

Sprockets made of stainless steel or plastic are available on request. For untoleranced dimensions DIN ISO 2768 c applies.



Type A G

bent attachments, one side

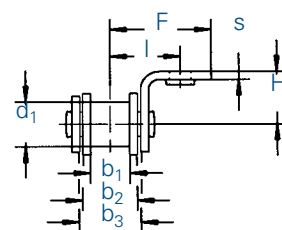
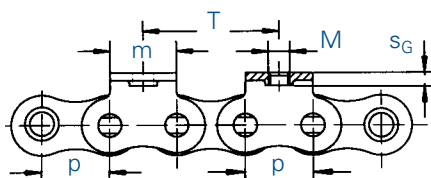

Type B G

bent attachments, both sides

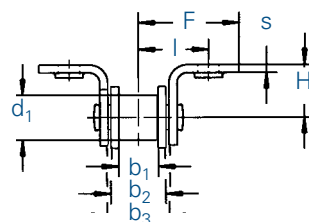
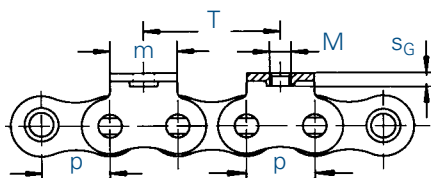

Type C G

bent over chain attachments, one side

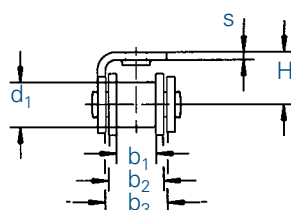
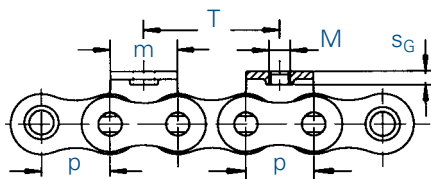

Type D G

straight attachments, one side

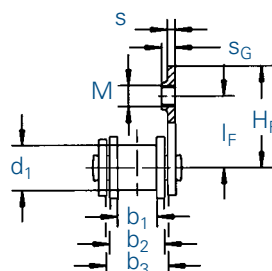
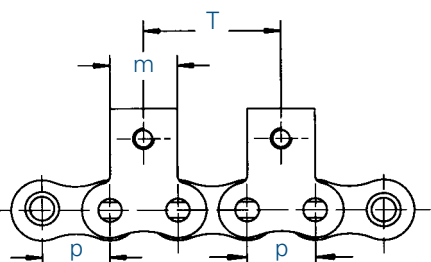

Type E G

straight attachments, both sides

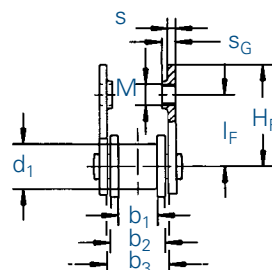
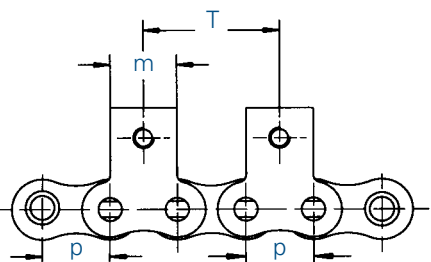

Basic chain		Pitch		Inner width	Inner link width	Outer plate width	Roller Ø	Plate height	Attachment dimensions						
No.	Ind.	p		b ₁ min.	b ₂ max.	b ₃ min.	d ₁ max.	g max.	m	Inside thread M	I	F	H	s	s _G
		mm	inch	mm	mm	mm	mm	mm	mm	mm	mm	mm	mm	mm	mm
462		12,7	1/2	7,75	11,30	11,43	8,51	11,8	12,5	M 4	13,1	19,0	10	1,50	4,00
501		15,875	5/8	9,65	13,28	13,41	10,16	14,7	15,0	M 5	16,7	27,0	10	1,70	4,20
513		19,05	3/4	11,68	15,62	15,75	12,07	16,1	18,5	M 6	18,6	29,0	11	1,80	4,50
548		25,4	1	17,02	25,40	25,60	15,88	21,0	25,0	M 8	28,9	41,8	18	3,00	7,50

For untoleranced dimensions DIN ISO 2768 c applies.



MARATHON CHAINS WITH TWO-HOLE BENT AND STRAIGHT ATTACHMENTS

Main dimensions according to DIN 8187

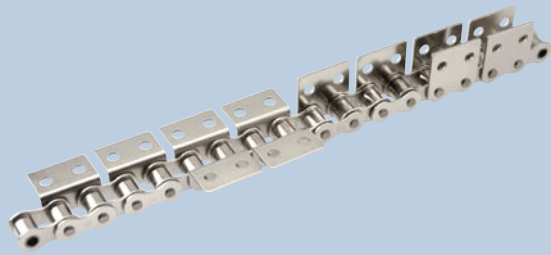

Type A2 bent attachments, one side

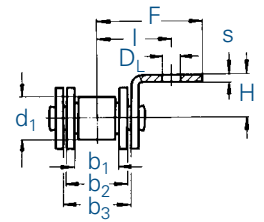
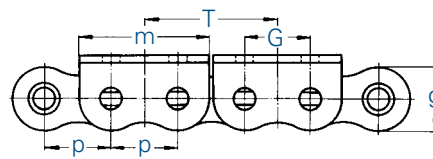

Type B2 bent attachments, both sides

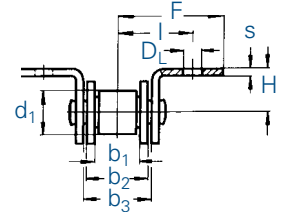
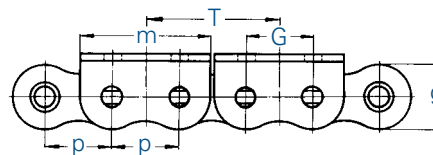

Type D2 straight attachments, one side

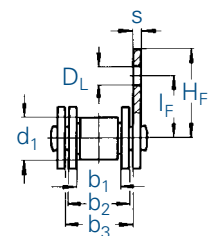
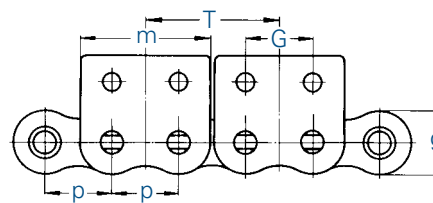

Type E2 straight attachments, both sides

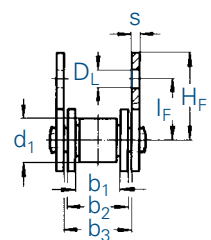
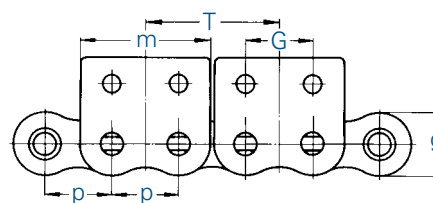

Basic chain		Pitch		Inner width	Inner link width	Outer plate width	Roller Ø	Plate height	Attachment dimensions								
No.	Ind.	p		b ₁ min.	b ₂ max.	b ₃ min.	d ₁ max.	g max.	m	D _L	G	I	F	H	I _F	H _F	s
		mm	inch	mm	mm	mm	mm	mm	mm	mm	mm	mm	mm	mm	mm	mm	mm
455	¹	9,525	3/8	5,72	8,53	8,66	6,35	8,2	18,2	3,2	9,5	9,8	13,2	5,7	9,2	12,6	1,25
462		12,7	1/2	7,75	11,30	11,43	8,51	11,8	23,2	4,5	12,7	13,1	19,0	10,0	14,7	20,3	1,50
501		15,875	5/8	9,65	13,28	13,41	10,16	14,7	28,5	5,5	15,9	16,7	27,0	10,0	17,2	26,7	1,70
513		19,05	3/4	11,68	15,62	15,75	12,07	16,1	33,6	6,6	19,1	18,6	29,0	11,0	18,7	29,0	1,80
548		25,4	1	17,02	25,40	25,60	15,88	21,0	46,5	9,0	25,4	28,9	42,0	18,0	28,6	41,5	3,00
563		31,75	1 1/4	19,56	29,00	29,20	19,05	26,4	55,8	9,0	31,8	33,4	49,0	18,0	30,5	46,0	3,75
596		38,1	1 1/2	25,40	37,90	38,20	25,40	33,4	71,1	11,0	38,1	44,0	64,0	25,0	41,0	60,0	5,00

¹ with straight side plates

Sprockets made of steel or plastic are available on request. For untoleranced dimensions DIN ISO 2768 c applies.

Type A 2 G

bent attachments, one side

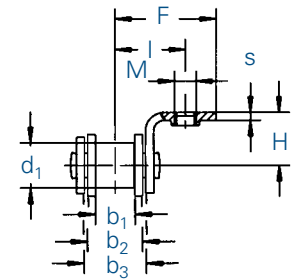
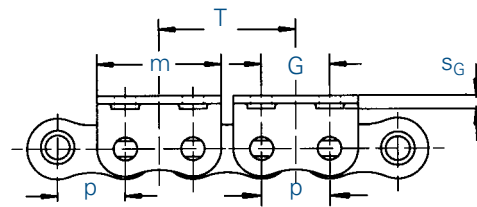

Type B 2 G

bent attachments, both sides

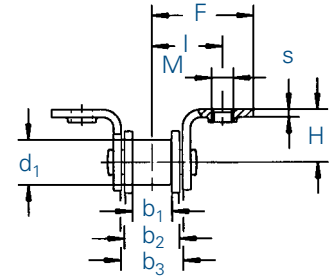
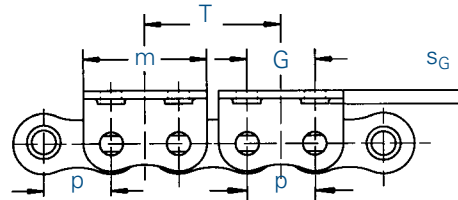

Type D 2 G

straight attachments, one side

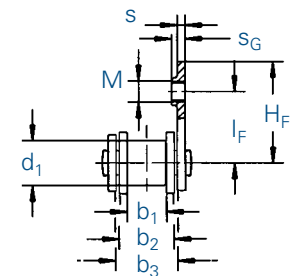
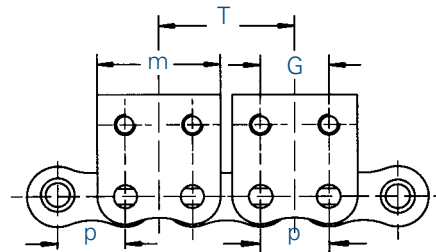

Type E 2 G

straight attachments, both sides

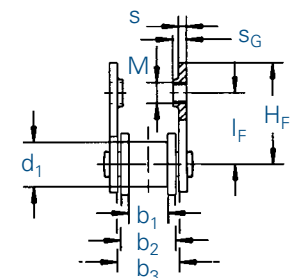
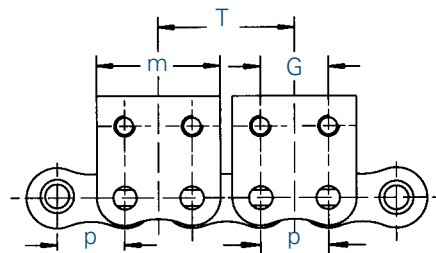

Type F

extended pins
(available on alternate sides)

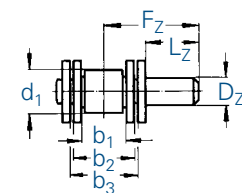
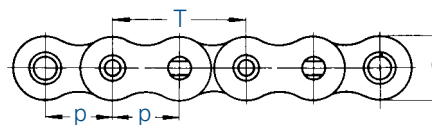

Basic chain	Pitch	Inner width		Outer plate width	Roller Ø	Plate height	Attachment dimensions													
		b ₁ min.	b ₂ max.				m	Inside thread M	G	I	F	H	I _F	H _F	s	s _G	D _Z	L _Z	F _Z	
No.	Ind.	mm	mm	mm	mm	mm	mm	mm		mm	mm	mm	mm	mm	mm	mm	mm	mm	mm	mm
462	²²	12,7	7,75	11,30	11,43	8,51	11,8	23,2	M 4	12,7	13,1	19,0	10	14,7	20,3	1,50	4,00	6,0	15,0	22,4
501	²²	15,875	9,65	13,28	13,41	10,16	14,7	28,5	M 5	15,9	16,7	27,0	10	17,2	26,7	1,70	4,20	6,5	20,0	28,5
513	²²	19,05	11,68	15,62	15,75	12,07	16,1	33,6	M 6	19,1	18,5	29,0	11	18,7	29,0	1,80	4,50	7,0	20,0	29,8
548	²²	25,4	17,02	25,40	25,60	15,88	21,0	46,5	M 8	25,4	28,9	41,8	18	28,6	41,5	3,00	7,50	10,0	30,0	45,9

For untoleranced dimensions DIN ISO 2768 c applies. Other types on request.



Type A

bent attachments, one side

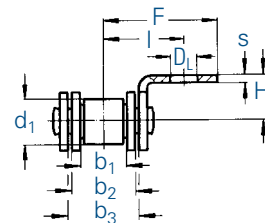
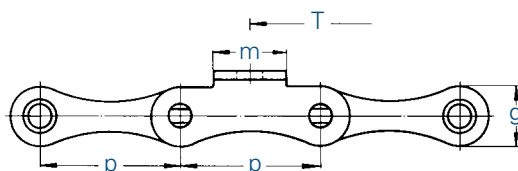

Type B

bent attachments, both sides

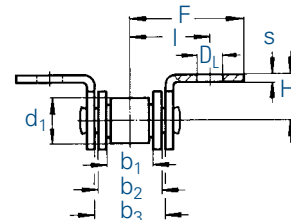
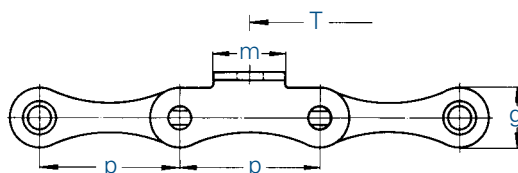

Type C

bent over chain attachments, one side

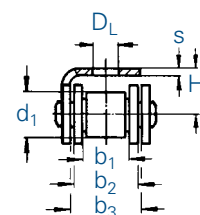
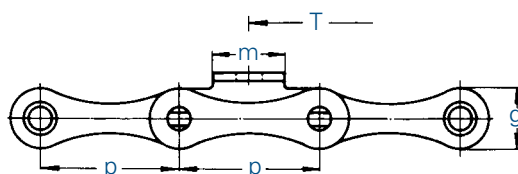

Type D

straight attachments, one side

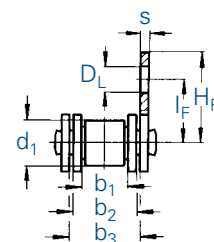
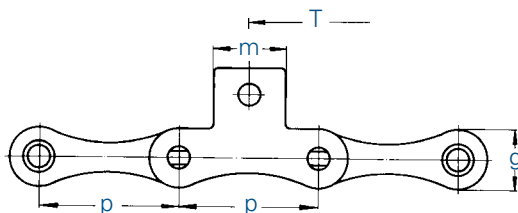

Type E

straight attachments, both sides

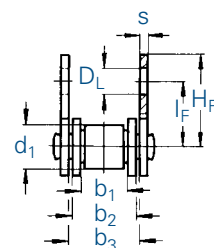
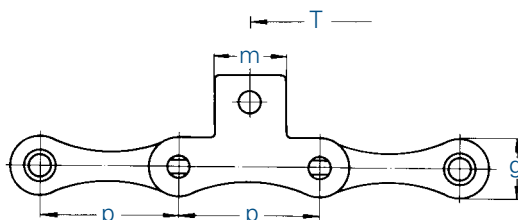

Type F

extended pin
(available on alternate sides)

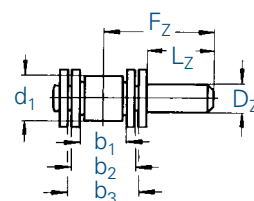
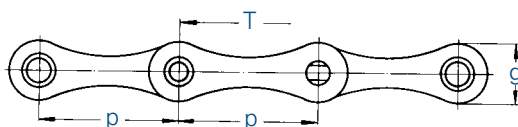

Pitch	Pitch		Inner width	Inner link width	Outer plate width	Roller Ø	Plate height	Attachment dimensions												
	No.	Ind.						p		b ₁ min.	b ₂ max.	b ₃ min.	d ₁ max.	g max.	m	D _L	l	F	H	I _F
208 B MA					25,4	1	7,75	11,30	11,43	8,51	11,8	13,0	4,5	13,1	19,3	10,0	14,7	20,3	1,60	6,0
210 B MA			31,75	1¼	9,65	13,28	13,41	10,16	14,7	15,0	5,5	16,7	26,7	10,0	17,0	26,7	1,70	6,5	20,0	28,5
212 B MA			38,1	1½	11,68	15,62	15,75	12,07	16,1	19,0	6,6	18,5	26,0	11,0	17,6	26,0	1,80	7,0	20,0	29,8
216 B MA			50,8	2	17,02	25,40	25,60	15,88	21,0	30,0	9,0	28,9	43,0	18,0	29,0	42,5	3,00	10,0	30,0	45,9
220 B MA			63,5	2½	19,56	29,00	29,20	19,05	28,5	35,0	9,0	33,1	49,6	18,0	30,5	45,7	3,75	12,0	30,0	48,4



Simplex chain
with duplex connecting link

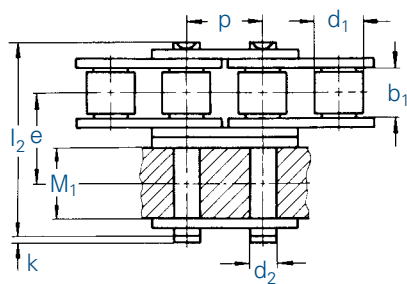

Simplex chain
with triplex connecting link

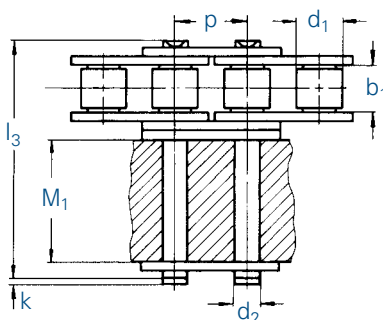

Simplex chain
with duplex connecting link

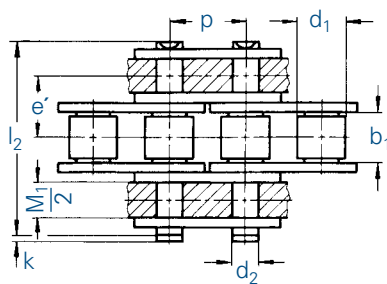

Duplex chain
with triplex connecting link

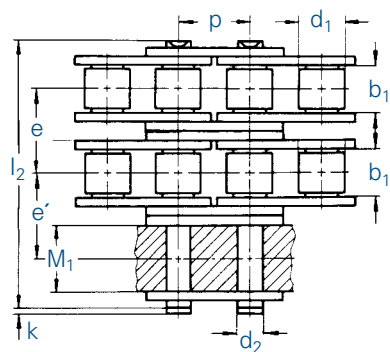

Duplex chain
with triplex connecting link

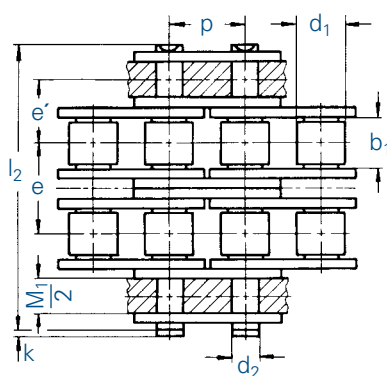

Chain	Pitch	Inner width	Roller Ø	Pin Ø	Transverse pitch		Attachment width		Projection over connecting link	Pin length		
					e	e'	M ₁ max.	M ₂ max.		k max.	l ₂ max.	l ₃ max.
No.	Ind.	p	b ₁ min.	d ₁ max.	d ₂ max.	mm	mm	mm	mm	mm	mm	mm
455	¹	9,525 3/8	5,72	6,35	3,28	10,24	7,24	8,5	-	3,3	23,8	-
D 455	¹	9,525 3/8	5,72	6,35	3,28	10,24	7,24	8,5	-	3,3	-	34,0
462		12,7 1/2	7,75	8,51	4,45	13,92	10,10	11,3	25,6	3,9	31,0	-
D 462		12,7 1/2	7,75	8,51	4,45	13,92	10,10	11,3	-	3,9	-	44,9
501		15,875 5/8	9,65	10,16	5,08	16,59	11,62	13,3	30,0	4,1	36,2	-
D 501		15,875 5/8	9,65	10,16	5,08	16,59	11,62	13,3	-	4,1	-	52,8
513		19,05 3/4	11,68	12,07	5,72	19,46	13,63	15,6	34,8	4,6	42,2	-
D 513		19,05 3/4	11,68	12,07	5,72	19,46	13,63	15,6	-	4,6	-	61,7

¹ with straight side plates

For untoleranced dimensions DIN ISO 2768 c applies.

Address

Wippermann jr. GmbH
Delsterner Straße 133
58091 Hagen, Germany

Postfach 4020
58040 Hagen, Germany

Phone
Fax

+49 (0) 2331-782-0
+49 (0) 2331-782-356

Homepage
E-mail

www.wippermann.com
info@wippermann.com